

























CONDUCTOR CABLES and Fittings



CONTENTS		Page		Page
General		2-5	Rondoflex rubber sheathed round cable, shielded	 15
PVC flat cables		6	PVC control cable with two tension	
PVC flat cables, specials or with shielding		7	reliefs, outwards	 16
Polychloroprene (Neoprene) flat cable			Neoprene control cable with tension reliefs	 17
acc. to DIN VDE 0250-UL-file E 113313		8	Cable glands	  18
Polychloroprene (Neoprene) flat cable			Components	  19
with copper wire – EMV qualified		9	Cable combination connectors	  20
Rubber sheathed round cable		10	Cable-connectors & glands	  21
Tough rubber sheathed round cable (K)		11	Terminal clamps & components	  22
Cordaflex (K) rubber sheathed round cable		12	Terminal boxes	  23
Optoflex rubber sheathed round cable		13	Questionnaire	26
Rondoflex rubber sheathed round cable		14	Photos	9, 16, 24, 25

This catalog contains information on flexible conductor cable up to 1000 Volt rating and all fittings mainly used for our

- cable tenders
- cable carriers
- spring cable reels
- motor cable reels
- catalog 7
- catalog 8a, 8bF, 8bR und 8c
- catalog 9a
- catalog 10

Our experts will be pleased to recommend the best suitable cable for your application and your detailed inquiry using the questionnaire on page 26 of this catalog would be highly appreciated.

Cables for medium and high voltage ratings and special designs are also available. Please consult the factory.

Cable dimensions comply with VDE regulations and other international standards.

Actual cable dimensions and international or local safety requirements have to be considered for the design and layout of the cable carrying and guiding equipment.

The listed current-carrying capacities refer to:

- max. 4 simultaneously loaded conductors of multi-core cables
- ambient temperature + 30° C
- continuous duty
- stretched laying
- no grouping of cables

Minimum bending radius for cables as per VDE 0298, part 3, table 2:

Application	Nominal voltage up to 1000 V			
	diameter of round cables or thickness of flat cables (d) in mm			
	up to 8 mm	8 - 12 mm	12 - 20 mm	over 20 mm
cable carriers	3 d	4 d	5 d	5 d
cable reels	5 d	5 d	5 d	6 d
cable tenders or guiding devices	7.5 d	7.5 d	7.5 d	7.5 d
unsupported and for connections	3 d	4 d	5 d	5 d
straigh installation	3 d	3 d	4 d	4 d



1. Determination of ampacity

a) Rated currents and starting currents of motors

Table 1:

Nominal output	Three-phase cage rotor (1500 U/min, 50 Hz)											Direct current motor			
	Efficiency	Power factors		Motor current								Efficiency	Motor current		
		230 V	400 V	500 V	660 V	110 V	220 V	440 V							
P	η	$\cos \varphi_N$	$\cos \varphi_A$	I_N	I_A	I_N	I_A	I_N	I_A	I_N	I_A	η	I_N	I_N	I_N
kW	%			A	A	A	A	A	A	A	A	%	A	A	A
0,75	74,5	0,78	0,76	3,2	14,4	1,8	8,1	1,5	6,8	1,1	5	75	9,2	4,6	2,3
1,1	75	0,81	0,76	4,3	19,8	2,5	11,5	2	9,2	1,5	6,9	75	13,5	6,8	3,3
1,5	77	0,82	0,76	5,8	27,3	3,3	15,5	2,6	12,2	2	9,4	77	17,2	8,7	4,4
2,2	80	0,82	0,73	8,2	39,4	4,7	22,6	3,7	17,8	2,9	14	78	27	13,3	6,7
3	80	0,79	0,73	11,1	54,4	6,4	31,4	5	24,5	3,5	17,2	80	34	17	8,5
4	82	0,84	0,73	14,6	73	8,4	42	6,4	32	4,9	24,5	80	45	22	11
5,5	83	0,85	0,65	19,6	100	11,3	57,6	8,6	43,9	6,7	34,2	84	61	30	15,5
7,5	85	0,86	0,65	25,8	134,2	14,8	77	11,5	59,8	9	46,8	85	82	41	21
11	87	0,86	0,60	36,9	195,6	21,2	112,4	17	90,1	13	68,9	86	120	60	30
15	87	0,86	0,60	50	270	29	156,6	22,5	121,5	17,5	94,5	87	160	81	41
18,5	88	0,86	0,60	61	335,5	35	192,5	27	148,5	21	115,5	88	195	97	49
22	89	0,87	0,60	71	398	41	230	32	179	25	140	89	232	116	58
30	90	0,87	0,60	96	547	55	314	43	245	33	188	89	315	155	78
37	90	0,87	0,60	119	690	68	394	54	313	42	244	89	384	190	96
45	91	0,88	0,60	141	832	81	478	64	378	49	289	90	462	230	116
55	91	0,88	0,60	172	—	99	594	78	468	60	360	91	—	282	140
75	91	0,88	0,60	235	—	135	826	106	647	82	500	92	—	280	190
90	92	0,88	0,60	279	—	160	992	127	787	98	608	93	—	—	225
110	92	0,88	0,60	341	—	196	—	154	970	118	743	93	—	—	277
132	92	0,88	0,60	409	—	235	—	182	—	140	896	93	—	—	330
160	93	0,88	0,60	491	—	282	—	220	—	170	—	93	—	—	—

This table shows typical running values which should only be used if there are no other manufacturers instructions.

Directions: Rated current: I_N Cage rotor motors: $X = 6$ $I_A = X \cdot I_N$
 Starting current: I_A Slipring rotor motor: $X = 2$
 Frequency regulated drives: $X = 1,5$

The starting currents resp. starting factors for squirrel cage motors do apply for direct net termination, only. If you do not find the required motor output in this table use formula as per section 1.

b) Calculation of nominal current (I_N), if motor power is known but not listed in table No. 1:

For three-phase drive:
$$I_N = \frac{P_N [kW] \cdot 1000}{\sqrt{3} \cdot U [V] \cdot \cos \varphi_N \cdot \eta}$$

Approximately:

For DC motors:
$$I_N = \frac{P_N [kW] \cdot 1000}{U [V] \cdot \eta}$$

$\cos \varphi_N = 0,85$
 $\eta = 0,85$ (efficiency)

For AC motors:
$$I_N = \frac{P_N [kW] \cdot 1000}{U [V] \cdot \cos \varphi_N \cdot \eta}$$



2. Cable selection for intermittent periodic duty motor operation

a) According to the nominal current I_N select the cable cross section from the corresponding cable tables (pages 6 to 18)

b) De-rating factors f_1 for intermittent periodic duty:

Cross section [mm ²]	Factors (f_1) for intermittent periodic duty with ED			
	60 %	40 %	25 %	15 %
1,5	1,00	1,00	1,00	1,00
2,5	1,00	1,00	1,04	1,07
4	1,00	1,03	1,05	1,19
6	1,00	1,04	1,013	1,27
10	1,03	1,09	1,21	1,44
16	1,07	1,16	1,34	1,62
25	1,10	1,23	1,46	1,79
35	1,13	1,28	1,53	1,90
50	1,16	1,34	1,62	2,03
70	1,18	1,38	1,69	2,13
95	1,20	1,42	1,74	2,21
120	1,21	1,44	1,78	2,26

c) De-rating factors f_2 for varying ambient temperatures

Isolating Material	Rubber	PVC	Special Compound
max. operation temperature	60°	70°	90°
Ambient temperature °C	De-rating factor f_2		
10	1,29	1,22	1,18
15	1,22	1,17	1,14
20	1,15	1,12	1,10
25	1,08	1,06	1,05
30	1,00	1,00	1,00
35	0,91	0,94	0,95
40	0,82	0,87	0,89
45	0,71	0,79	0,84
50	0,58	0,71	0,77
55	0,41	0,61	0,71
60	–	0,50	0,63

d) De-rating factors f_3 for multi-core cables:

number of loaded cores	5	7	10	14	19	24	40
de-rating factor f_3	0,75	0,65	0,55	0,5	0,45	0,4	0,35

e) Permissible cable ampacity under consideration of operation condition

$$I_{zul} = I_{max} \cdot f_1 \cdot f_2 \cdot f_3$$

Remark: The installation condition has not been considered (cable festoon system ≈ 1 , for cable reels see cat. No. 10) I_{max} as per tables pages 6 to 17

f) Revision of cross section selected under 2a:

$$I_N \leq I_{zul}$$

I_N = nominal current

I_{zul} = permissible cable ampacity under consideration of operation conditions

g) If the a. m. condition are not met under 2f, repeat steps 2a to 2e with changed cross section.



3. Voltage Drop calculation for starting current

- a) If not specified by others a voltage drop of max. 3 % of the nominal voltage can be considered as standard value. In case this value is exceeded a reduction of the voltage drop is achieved by increasing the cross section. If the a. m. measure is insufficient booster cables have to be used.
- b) If the nominal current I_N has been determined as per table No. 1 check voltage drop by using the figures for starting current I_A .
- c) Determination of max. starting current of the installation (I_A), if nominal current has been calculated as per 1b. For starting current use x-fold the nominal current according to the used motor type (see 1a, table 1)

$$I_A = I_N \cdot X$$

d) Voltage drop

For three-phase current $\Delta U = \sqrt{3} \cdot I \cdot I_A \cdot Z$

For alternating current $\Delta U = 2 \cdot I \cdot I_A \cdot Z$

For direct current $\Delta U = 2 \cdot I \cdot I_A \cdot R$

Z = Impedance [Ω /km]

R = Resistance [Ω /km]

l = Feed length [km]

I_A = Starting current in amps

Table 7: Effective Resistance

Cross section [mm ²]	Z for three-phase or AC current cos $\varphi = 0,6$ f = 50 Hz [Ω /km]	R for DC current [Ω /km]
1,5	8,770	14,470
2,5	5,310	8,710
4	3,360	5,450
6	2,250	3,620
10	1,370	2,160
16	0,888	1,360
25	0,587	0,863
35	0,443	0,627
50	0,344	0,463
70	0,258	0,321
95	0,205	0,231
120	0,174	0,183



PVC FLAT CABLES

Application: Cable Carriers



Application

Power and control cables for cranes and material handling equipment, machine tools etc. associated with medium mechanical stresses and frequent bending during operation in one plane only; for dry, humid or wet room application.

Technical Data

Temperature range: - 30° C to + 70° C
 Nominal voltage U_0/U : 05VVH6 300/500 V
 07VVH6 450/750 V

Type	Number & size of conductors [mm ²]	Outside dimensions height x width		Capacity max. at 30° C* I_{max} [A]	Flat cable glands	Weight [kg/m]	Cat.-No.
		min. [mm]	max. [mm]				
HO5VVH6-F	24 G 1	4,4 x 70,4	4,6 x 70,6	15	-	0,590	332 081
HO7VVH6-F	4 G 1,5	4,9 x 14,5	5,2 x 15,5	18	Pg 16	0,150	331 353
	4 X 1,5	4,9 x 14,5	5,2 x 15,5		Pg 16	0,150	330 230
	5 G 1,5	4,9 x 17,5	5,2 x 18,5		Pg 21	0,180	332 080
	7 G 1,5	4,9 x 24,5	5,2 x 26,5		Pg 29	0,260	331 481
	8 G 1,5	4,9 x 27,0	5,2 x 28,5		Pg 29	0,295	331 354
	8 X 1,5	4,9 x 27,0	5,2 x 28,5		Pg 29	0,295	331 724
	10 G 1,5	4,9 x 36,0	5,2 x 38,0		Pg 36	0,355	335 060
	10 X 1,5**	4,9 x 36,0	5,2 x 38,0		Pg 36	0,355	332 083
	12 G 1,5	4,9 x 39,5	5,2 x 41,5		Pg 42	0,415	331 355
	12 X 1,5	4,9 x 39,5	5,2 x 41,5		Pg 42	0,415	331 707
	13 G 1,5**	4,9 x 48,1	5,2 x 49,5	Pg 48-1	0,430	332 084	
	24 G 1,5	4,9 x 79,6	5,2 x 81,0	-	0,790	332 625	
	26	4 G 2,5	5,6 x 18,0	5,9 x 19,0	Pg 21	0,210	331 356
		5 G 2,5	5,6 x 21,5	5,9 x 22,5	Pg 29	0,260	332 100
		7 G 2,5	5,6 x 30,1	5,9 x 31,6	Pg 36	0,380	332 110
		8 G 2,5	5,6 x 33,7	5,9 x 35,7	Pg 36	0,405	331 357
		10 G 2,5	5,6 x 43,8	5,9 x 45,2	Pg 42	0,505	331 643
		12 G 2,5	5,6 x 49,5	5,9 x 52,0	Pg 48-1	0,610	331 358
		24 G 2,5	5,6 x 97,0	5,9 x 99,0	-	1,160	331 641
		34	4 G 4	6,8 x 21,0	7,1 x 22,0	Pg 29	0,300
5 G 4	6,8 x 25,5		7,1 x 26,5	Pg 29	0,370	331 364	
7 G 4	6,8 x 37,0		7,1 x 39,0	Pg 36	0,550	331 365	
44	4 G 6	7,5 x 24,0	7,8 x 25,0	Pg 29	0,385	331 360	
	5 G 6	7,5 x 29,0	7,8 x 30,0	Pg 29	0,530	331 366	
	7 G 6	7,5 x 40,5	7,8 x 42,5	Pg 42	0,750	331 367	
61	4 G 10	9,4 x 30,0	9,9 x 31,5	Pg 36	0,620	331 361	
	5 G 10	9,9 x 35,5	10,2 x 37,5	Pg 36	0,810	332 085	
82	4 G 16	10,7 x 34,5	11,2 x 36,5	Pg 42	0,970	331 362	
	5 G 16	10,9 x 41,8	11,2 x 43,4	Pg 42	1,130	331 487	
AO7VVH6-F	4 G 25	12,4 x 40,5	13,0 x 42,5	108	Pg 48-1	1,405	331 363
	5 G 25**	15,6 x 53,5	16,0 x 56,0		Pg 48-1	1,730	332 086
(H) O7VVH6-F	4 G 35	14,4 x 49,1	14,8 x 50,5	135	Pg 48-1	2,035	331 773
	4 G 50	16,1 x 54,6	16,5 x 56,0	168	-	2,650	331 853
	4 G 70	17,6 x 61,5	18,0 x 63,0	207	-	3,650	331 785
	4 G 95	20,1 x 70,6	20,5 x 72,5	250	-	4,550	332 087



Application

Power and control cables for cranes and material handling equipment, machine tools etc. associated with medium mechanical stresses and frequent bending during operation in one plane only; for dry, humid or wet room application.

Technical data

Temperature range: - 30° C to + 70° C
Nominal voltage U_0/U : 300/500 V

Type	Number & size of conductors [mm ²]	Description	Outside dimensions height x width [ca. mm]	Capacity max. at 30° C* I_{max} [A]	Flat cable glands	Weight [kg/m]	Cat.-No.
YFLY-J	7 x 3 x 1	3 cores common shielding	10,3 x 50	15	Pg 48-1	0,710	331 968
	14 x 3 x 1		10,3 x 100		-	1,420	332 098
YFLY-O	7 x 4 x 0,5	4 cores common shielding	10,3 x 50	2,5	Pg 48-1	0,675	332 101
	14 x 4 x 0,5		10,3 x 100		-	1,350	332 102

Type	Number & size of conductors [mm ²]	Description	Outside dimensions height x width [ca. mm]	Capacity max. at 30° C* I_{max} [A]	Flat cable glands	Weight [kg/m]	Cat.-No.
YCFLY-O	5 x 0,5	Individually shielded cores	4,4 x 20,4	2,5	Pg 21	0,100	331 655
	4 x 1		5,0 x 13,9	15	Pg 16	0,131	332 623
	4 x 1,5		5,5 x 18,0	18	Pg 21	0,160	331 976
	8 x 1,5		5,5 x 34,0		Pg 36	0,380	332 055
	12 x 1,5		5,5 x 50,5		Pg 48-1	0,569	331 829
YCFLY-J	8 x 1,5		5,5 x 34,0	26	Pg 36	0,380	331 918
	4 x 2,5		6,5 x 21,0		Pg 21	0,280	332 103
	6 x 2,5		7,2 x 37,4	Pg 42	0,410	332 104	
	4 x 4		7,5 x 23,0	34	Pg 29	0,380	332 105
	4 x 6		9,0 x 29,0	44	Pg 29	0,580	332 106
	4 x 10	11,0 x 37,0	61	Pg 36	0,900	332 107	
	4 x 16	14,0 x 46,0	82	Pg 48-1	1,280	332 099	
YFLCY-O	7 x 2 x 0,75 PiC	Shielded pairs	10,3 x 50,0	12	Pg 48-1	0,750	331 715
	14 x 2 x 0,75 PiC		10,3 x 100		-	1,500	332 108
YFLCY-O	5 x 4 x 0,5	4 cores common shielding	7,2 x 37,4	2,5	Pg 36	0,439	332 074
	7 x 4 x 0,5		10,3 x 50,0		Pg 48-1	0,745	331 923
	14 x 4 x 0,5		10,3 x 100,0		-	1,490	332 109
YFLCY-JZ	8 x 7 x 0,5	7 cores common shielding	11,7 x 68,5	15	-	1,180	331 370
	4 x 4 x 1	4 cores common shielding	11,0 x 33,5		Pg 36	0,500	331 371
YFLCY-J	7 x 3 x 1	3 cores common shielding	10,3 x 50,0	15	Pg 48-1	0,755	331 979
YFLCY-JJ	14 x 3 x 1		10,3 x 100,0		-	1,510	331 909

* De-rating factors are not considered (2. Selection of cables, page 4)



POLYCHLOROPRENE (NEOPRENE) FLAT CABLES

to DIN VDE 0250-UL-file E 113313 for Cable Carriers



Application

Power and control cables for cranes and material handling equipment, machine tools etc. associated with medium mechanical stresses and frequent bending during operation in one plane only; for dry, humid or wet room application.

Technical data

Temperature range: - 35° C to + 90° C
Nominal voltage U_0/U : 300/500 V

Type	Number & size of conductors [mm ²]	Outside dimensions height x width		Capacity max. at 30° C* I_{max} [A]	Flat cable glands	Weight [kg/m]	Cat.-No.
		min. [mm]	max. [mm]				
NGFLGÖU-J	4 x 1,5	5,4 x 15,0	6,4 x 18,5	18	Pg 21	0,171	331 373
	5 x 1,5	5,4 x 18,5	6,4 x 21,5		Pg 29	0,214	330 660
	7 x 1,5	5,4 x 25,0	6,4 x 30,0		Pg 29	0,292	330 670
	8 x 1,5	5,4 x 27,5	6,4 x 32,0		Pg 36	0,325	331 374
	10 x 1,5	6,0 x 35,5	7,0 x 41,5		Pg 42	0,455	331 375
	12 x 1,5	6,0 x 42,0	7,0 x 48,5		Pg 48-1	0,550	331 376
	6 x 4 x 1,5	11,5 x 51,0	13,5 x 56,0		-	1,050	332 088
	4 x 2,5	6,6 x 18,5	8,2 x 24,0	26	Pg 29	0,257	330 680
	5 x 2,5	6,6 x 22,5	8,2 x 28,5		Pg 29	0,332	330 690
	7 x 2,5	6,6 x 31,0	8,2 x 39,5		Pg 36	0,452	330 700
	8 x 2,5	6,6 x 33,5	8,2 x 42,5		Pg 42	0,510	330 710
	10 x 2,5	7,2 x 43,0	8,8 x 54,5		Pg 48-1	0,620	331 378
	12 x 2,5	7,2 x 50,5	8,8 x 63,5		Pg 48-2	0,810	330 720
	6 x 4 x 2,5	15,0 x 66,0	17,0 x 72,5		-	1,730	332 089
	4 x 4	7,9 x 22,5	9,6 x 28,0	34	Pg 29	0,402	331 380
	5 x 4	7,9 x 27,0	9,6 x 33,5		Pg 36	0,540	331 381
	7 x 4	7,9 x 37,0	9,6 x 46,5		Pg 42	0,720	331 401
	4 x 6	8,5 x 24,5	10,4 x 31,0	44	Pg 29	0,510	330 730
	5 x 6	8,5 x 29,5	10,4 x 37,5		Pg 36	0,670	331 382
	7 x 6	8,5 x 41,0	10,4 x 51,5		Pg 48-1	0,910	331 402
	4 x 10	9,9 x 30,0	12,1 x 38,0	61	Pg 36	0,770	330 740
	5 x 10**	9,9 x 36,5	12,1 x 45,5		Pg 42	0,946	331 383
	7 x 10	9,9 x 50,5	12,1 x 63,5		-	1,370	331 403
	4 x 16	11,5 x 35,0	14,0 x 44,0	82	Pg 42	1,100	330 750
	5 x 16**	11,5 x 42,5	14,0 x 53,0		Pg 48-1	1,450	331 384
	7 x 16	12,1 x 59,5	14,6 x 74,0		-	1,990	331 678
	4 x 25	13,1 x 41,5	15,7 x 51,0	108	Pg 48-1	1,560	330 760
	5 x 25**	13,7 x 51,0	16,3 x 62,5		-	2,200	331 385
	7 x 25	14,3 x 71,5	17,0 x 88,5		-	2,930	331 386
	4 x 35	14,8 x 47,0	18,0 x 58,5	135	-	2,100	330 770
	7 x 35	15,4 x 79,5	18,6 x 99,5		-	3,820	331 388
	4 x 50	17,2 x 55,0	21,0 x 69,0		-	2,960	331 389
4 x 70	19,5 x 62,5	23,7 x 78,0	207	-	4,000	331 390	
4 x 95	22,0 x 71,0	26,9 x 89,0	250	-	5,470	331 391	
GFLGÖU-J	4 x 120	ca. 26,9 x 85,5		292	-	6,400	331 392



POLYCHLOROPRENE (NEOPRENE) FLAT CABLES

with copper wire -EMV- qualified for Cable Carriers



Application

Power and control cables for cranes and material handling equipment, machine tools etc. associated with medium mechanical stresses and frequent bending during operation in one plane only; for dry, humid or wet room application.

Technical data

Temperature range: - 35° C to + 90° C
Nominal voltage U_0/U : 300/500 V

Type	Number & size of conductors [mm ²]	Description	Outside dimensions height x width [ca. mm]	Capacity max. at 30° C* I_{max} [A]	Flat cable glands	Weight [kg/m]	Cat.-No.
GCFLGÖU-J	4 x 1,5	individually shielded cores	6,3 x 17,9	18	Pg 21	0,224	332 138
	8 x 1,5		7,3 x 38,0		Pg 36	0,650	332 139
	10 x 1,5		8,4 x 55,1		Pg 48-2	0,790	332 176
	12 x 1,5		8,4 x 62,4		-	0,970	332 141
	4 x 2,5		8,5 x 25,5	26	Pg 29	0,420	332 142
	6 x 2,5		8,5 x 35,5		Pg 36	0,610	332 143
	12 x 2,5		8,9 x 68,0		-	1,100	332 144
	4 x 4		10,0 x 30,0		Pg 29	0,510	332 145
	4 x 6		11,0 x 32,2	44	Pg 36	0,590	332 146
	4 x 10		12,3 x 37,4	61	Pg 36	0,830	332 147
	4 x 16		14,0 x 42,4	82	Pg 42	1,090	332 148
	GCFLGÖU-O		4 x 1,5		6,9 x 18,5	18	Pg 21
8 x 1,5		6,9 x 35,1	Pg 36		0,510		332 151
12 x 1,5		7,5 x 51,8	Pg 48-2		0,820		332 152
GFLCGÖU-O	4 x (2 x 1) C	shielded pairs	10,6 x 31,8	15	Pg 36	0,663	332 153
	6 x (2 x 2,5) C		14,8 x 61,5	26	-	1,800	332 154



Vahle Flat Cable Festooning System for Stacker/Reclaimer Electrification

* De-rating factors are not considered (2. Selection of cables, page 4)



RUBBER SHEATHED ROUND CABLES

for Cable Carriers and Cable Reels with Low Duty Operation



Application

Power and control cable with medium mechanical stresses for dry, humid or wet rooms and for outdoor application.

Technical data

Temperature range: - 30° C to + 90° C
Nominal voltage U_0/U : 450/750 V

Type	Number & size of conductors [mm²]	O. D.		Capacity max. at 30° C* I_{max} [A]	Weight [kg/m]	Cat.-No.
		min. [mm]	max. [mm]			
HO7RN-F	1 x 1,5	appr. 6,5		24	0,055	332 177
	1 x 2,5	appr. 7,0		32	0,072	331 996
	1 x 4	appr. 8,0		42	0,099	331 867
	1 x 6	appr. 9,0		54	0,130	331 667
	1 x 10	9,6	12,5	73	0,200	332 230
	1 x 16	11,0	14,5	98	0,278	332 240
	1 x 25	12,5	16,5	129	0,396	332 250
	1 x 35	14,0	18,5	158	0,520	332 260
	1 x 50	16,5	21,0	198	0,719	332 270
	1 x 70	18,5	23,5	245	0,947	332 280
	1 x 95	21,0	26,0	292	1,230	332 290
	1 x 120	23,5	28,5	344	1,520	332 300
	1 x 150	26,0	31,5	391	1,887	332 310
	1 x 185	appr. 30,0		448	2,274	331 473
	1 x 240	appr. 32,5		528	2,955	332 178
	1 x 300	appr. 37,0		608	3,585	332 179
	3 G 1,5	9,6	12,5	18	0,150	331 407
	3 G 2,5	11,5	14,5	26	0,217	331 408
	3 G 4	13,0	16,0	34	0,298	331 409
	3 G 6	14,5	20,0	44	0,387	331 410
	3 G 10	20,0	25,5	61	0,716	331 411
	3 G 16	22,5	29,5	82	1,008	331 412
	4 G 1,5	10,5	13,5	18	0,190	330 250
	4 G 2,5	12,5	15,5	26	0,269	330 260
	4 G 4	14,5	18,0	34	0,373	330 270
	4 G 6	16,5	22,0	44	0,514	330 280
	4 G 10	21,5	28,0	61	0,898	330 290
	4 G 16	24,5	32,0	82	1,253	330 300
	4 G 25	29,5	37,5	108	1,846	330 310
	4 G 35	33,0	42,0	135	2,393	330 320
	4 G 50	38,0	48,5	168	3,284	330 330
	4 G 70	43,0	54,5	207	4,331	332 150
	4 G 95	49,0	60,5	250	5,712	331 413
4 G 120	appr. 58,0		292	6,828	332 181	
4 G 150	appr. 65,0		335	8,319	332 182	
4 G 185	appr. 69,5		382	10,062	332 183	
5 G 1,5	11,5	15,0	18	0,230	332 160	
5 G 2,5	13,5	17,0	26	0,329	332 170	
5 G 4	16,0	19,5	34	0,466	332 180	
5 G 6	18,0	24,5	44	0,640	332 190	
5 G 10	24,0	30,5	61	1,107	332 200	
5 G 16	27,0	35,5	82	1,564	332 210	
5 G 25	32,5	41,5	108	2,291	332 220	
5 G 35	appr. 42,7		135	3,060	331 929	
AO7RN-F	7 G 1,5	14,0	17,5	18	0,380	331 414
	7 G 2,5	16,5	20,0	26	0,520	331 415
	8 G 2,5	18,0	21,5	26	0,556	330 340
	12 G 1,5	19,9	21,7	18	0,507	331 416
	19 G 1,5	appr. 23,0		18	0,788	332 082
	12 G 2,5	18,5	26,5	26	0,710	330 350
	18 G 2,5	25,0	31,5	26	1,020	330 360
	24 G 1,5	26,1	27,9	18	0,968	331 418
	24 G 2,5	28,5	35,0	26	1,380	330 370
	3 x 1,5	9,6	12,5	18	0,150	332 320
	3 x 2,5	11,5	14,5	26	0,220	332 330
	3 x 4	13,0	16,0	34	0,305	332 340
	3 x 6	14,5	20,0	44	0,387	332 350
	3 x 10	20,0	25,5	61	0,722	332 360
3 x 16	22,5	29,5	82	1,018	332 370	



TOUGH RUBBER SHEATHED ROUND CABLES (K)

for Cable Reels, Cable-Guiding Devices and Cable Carriers



Application

Power and control cable with high mechanical stresses and frequent bending during operation; for dry, humid or wet rooms and for outdoor application.

Technical data

Temperature range:
Nominal voltage U_0/U :

- 35° C to +90° C
0,6/1kV

Typ	Number & size of conductors [mm ²]	O. D. [ca. mm]	Capacity max. at 30 ° C* I_{max} [A]	Weight [kg/m]	Cat.-No.
NSHTÖU-J	4 x 1,5	14,0	23	0,235	332 017
	5 x 1,5	15,0		0,276	332 018
	7 x 1,5	17,6		0,420	332 019
	12 x 1,5	21,3		0,625	332 021
	18 x 1,5	24,5		0,830	332 022
	24 x 1,5	28,0		1,080	332 023
	30 x 1,5	29,5		1,190	332 024
	42 x 1,5	35,0		1,733	332 184
	4 x 2,5	17,0	30	0,350	332 026
	5 x 2,5	18,0		0,410	332 027
	7 x 2,5	20,8		0,515	332 028
	12 x 2,5	24,4		0,840	332 029
	18 x 2,5	28,2		1,195	332 030
	24 x 2,5	33,0		1,570	332 031
	30 x 2,5	34,5		1,750	332 032
	4 x 4	19,0	41	0,490	332 034
	4 x 6	20,5	53	0,610	332 035
	4 x 10	24,7	74	0,940	332 036
	4 x 16	29,1	99	1,305	332 037
	4 x 25	34,4	130	1,950	332 038
	4 x 35	38,6	161	2,710	332 039
	4 x 50	45,0	202	3,790	332 002
	4 x 70	49,0	250	4,550	332 041
	4 x 95	58,0	300	6,080	332 042
	4 x 120	63,0	352	7,420	332 043
	4 x 150	66,5	404	8,905	332 044

Composite cables, cores unshielded and shielded

NSHTÖU-J	19 x 2,5 + 5 x 1,5 (C)**	33,8	30/23	1,570	332 046
	25 x 2,5 + 5 x 1,5 (C)**	35,0	30/23	1,740	332 045

Flexible power cables, three-core design with splitted earth conductor

NSHTÖU-J	3 x 70 + 3 x 35/3**	45,0	250	3,960	332 155
	3 x 95 + 3 x 50/3**	52,0	300	5,330	332 156

* De-rating factors are not considered (2. Selection of cables, page 4)

** Consult factory for delivery time



CORDAFLEX (SMK) RUBBER SHEATHED ROUND CABLES



for Cable Reels, Cable-Guiding Devices and Cable Carriers

Application

Power and control cable with very high mechanical stresses and frequent bending during operation; for dry, humid or wet rooms and for outdoor application.

Technical data

Temperature range: - 35° C to +90° C
Nominal voltage U_0/U : 0,6/1kV

Type	Number & size of conductors [mm ²]	O. D.		Capacity max. at 30° C* I_{max} [A]	Weight [kg/m]	Cat.-No.
		min. [mm]	max. [mm]			
(N)SHTÖU-J	4 x 1,5**	12,2	13,8	23	0,240	332 309
	5 x 1,5	13,0	14,6		0,280	332 311
	7 x 1,5	15,2	17,2		0,385	332 312
	12 x 1,5	21,4	23,4		0,710	332 313
	18 x 1,5	21,3	23,3		0,760	332 314
	24 x 1,5	23,8	26,8		0,990	332 315
	30 x 1,5**	26,6	29,6		1,220	332 316
	36 x 1,5**	26,5	29,5		1,260	332 317
	44 x 1,5**	29,5	32,5		1,530	332 318
	56 x 1,5**	34,9	37,9		2,050	332 319
	4 x 2,5	13,2	14,8	30	0,305	332 321
	5 x 2,5	14,2	15,8		0,355	332 322
	7 x 2,5	16,6	18,6		0,510	332 323
	12 x 2,5	23,4	25,4		0,920	332 324
	18 x 2,5	23,3	25,3		1,005	332 325
	24 x 2,5	26,2	29,2		1,320	332 326
	30 x 2,5	29,4	32,4		1,660	332 327
	36 x 2,5	29,3	32,3		1,720	332 328
	44 x 2,5	34,1	37,1		2,230	332 329
	56 x 2,5**	40,1	43,1		2,940	332 331
	4 x 4	16,0	18,0	41	0,455	332 291
	5 x 4	17,4	19,4	53	0,430	332 296
	4 x 6	17,4	19,4		0,575	332 292
	5 x 6	19,0	21,0	74	0,690	332 297
	4 x 10	21,6	23,6		0,905	332 293
	5 x 10	23,4	25,4	99	1,080	332 298
	4 x 16	23,7	26,7		1,240	332 294
	5 x 16	26,1	29,1		1,500	332 299
	4 x 25	28,5	31,5	131	1,850	332 295

Flexible power cables, three-core design with splitted earth conductor

(N)SHTÖU-J	3x 35+3x 16/3	28,5	31,5	162	2,160	332 301
	3x 50+3x 25/3	34,4	37,4	202	2,850	332 302
	3x 70+3x 35/3	39,7	42,7	250	3,920	332 303
	3x 95+3x 50/3	44,3	47,3	301	5,020	332 304
	3x 120+3x 70/3	51,0	55,0	352	6,630	332 305
	3x 150+3x 70/3	53,9	57,9	404	7,690	332 306
	3x 185+3x 95/3**	58,9	62,9	461	9,310	332 307
	3x 240+3x 120/3**	67,4	71,4	540	12,200	332 308

Control cables for horizontal payout with 20-kN tension relief

(N)SHTÖU-J	46 x 1 (20 kN)	26,6	29,6	18	1,190	332 332
	24 x 2,5 (20 kN)**	26,2	29,2	30	1,290	332 333
	30 x 2,5 (20 kN)	29,4	32,4		1,610	332 334
	44 x 2,5 (20 kN)	34,1	37,1		2,160	332 335
	56 x 2,5 (20 kN)**	40,1	43,1		2,840	332 336

Bus cables, twisted and shielded pairs

(N)SHTÖU-O	6 x (2 x 0,5) C**	23,1	25,1	2,5	0,885	332 337
	6 x (2 x 1,0) C	28,9	31,9	18,0	1,330	332 338

Composite cables, cores unshielded and shielded

(N)SHTÖU-J	19 x 2,5 + 5 x 1 (C)	26,2	29,2	30/18	1,290	332 339
	25 x 2,5 + 5 x 1 (C)	29,4	32,4		1,620	332 341



OPTOFLEX-RUBBER SHEATHED FIBRE-OPTIC CABLES

for Cable Reels (mono-spiral winding) Cable Carriers, Cable Tenders



Application

For optical signal and data transmission on cranes and material handling equipment: suitable for forced guidance (e. g. reels, festoon systems, cable tenders) at high data rates, large bandwidth and absolute immunity to electromagnetic interference. Unrestricted use indoors and outdoors, resistant to ozone and moisture.

Technical Data

Operation temperature	- 20° C to + 60° C
Tensile load	max. 300 N
Torsional stress at entries	50°/m
Minimum bending radii	125 mm
fixed installation and on festoons	125 mm
on reels and cable tenders	250 mm
Minimum distances with S-type directional changes	50 x D (D = cable dia.)
Travel speed:	
- Gantry	up to 120 m/min. (mono-spiral winding reels only)
- Trolley	up to 240 m/min. (festoons, cable tenders)
- Hoist	not suitable

Type	No. & size of conductors [mm ²]	O. D.		Weight [kg/m]	Cat.-No.
		min. [mm]	max. [mm]		
OPTOFLEX	4G 62,5 / 125 micron	14,9	16,9	0,240	332 164
	6G 62,5 / 125 micron**				331 792
	6G 50 / 125 micron**				331 925

Further types on request

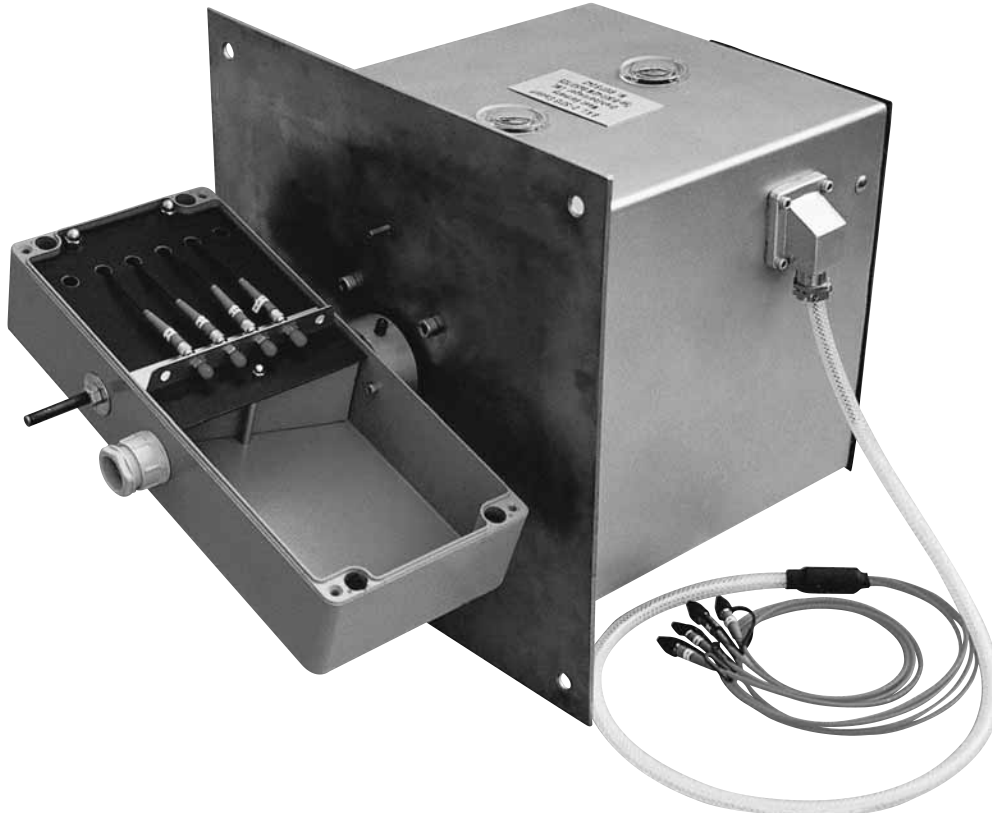

Rotary joint for fibre optics (in conjunction with slipping units on motor cable reels)

** Time of delivery on request



RONDoflex-RUBBER SHEATHED ROUND CABLES

for Cable Carriers and Cable Reels



Application

Power and control cable with high mechanical stresses and frequent bending during operation; for dry, humid or wet rooms and for outdoor application.

Technical Data

Temperature range: - 25° C bis +90° C
Nominal voltage U_0/U : 0,6/1kV

Type	Number & size of conductors [mm ²]	O. D.		Capacity max. at 30° C* I_{max} [A]	Weight [kg/m]	Cat.-No.
		min. [mm]	max. [mm]			
NGRDGÖU-O	1 x 35	12,3	13,9	162	0,430	331 914
	1 x 50	15,0	16,6	202	0,625	331 775
	1 x 70	16,5	18,5	250	0,835	331 869
	1 x 95	18,9	20,9	301	1,070	331 764
	1 x 120	20,8	22,8	352	1,340	331 836
	1 x 150	22,9	24,9	404	1,650	331 870
	1 x 185**	24,8	27,8	461	2,010	331 847
NGRDGÖU-J	12 x 1,5**	16,2	18,2	23	0,440	331 857
	18 x 1,5**	18,7	20,7		0,615	331 856
	24 x 1,5	22,1	24,1		0,805	331 861
	30 x 1,5**	23,3	25,3		0,930	332 122
	36 x 1,5**	24,6	27,6		1,090	332 123
	12 x 2,5	17,9	19,9	30	0,580	331 860
	18 x 2,5	21,5	23,5		0,865	331 871
	24 x 2,5	24,0	27,0		1,110	331 778
	30 x 2,5	26,4	29,4		1,330	338 008
	36 x 2,5**	28,4	31,4		1,550	332 124
	4 x 4	13,9	15,5	41	0,350	331 903
	5 x 4	15,7	17,7		0,450	331 902
	4 x 6	15,9	17,9	53	0,475	331 858
	5 x 6	17,5	19,5		0,575	331 777
	4 x 10	18,2	20,2	74	0,680	331 776
	5 x 10	20,8	22,8		0,865	331 765
	4 x 16	22,9	24,9	99	1,070	331 859
	5 x 16	24,6	27,6		1,300	331 872
	4 x 25	26,9	29,9	131	1,600	331 863
	5 x 25	29,5	32,5		1,940	331 848
4 x 35	30,1	33,1	2,090		331 873	
4 x 50	35,7	38,7	202	2,970	331 837	

Flexible power cables, three-core design with splitted earth conductor

NGRDGÖU-J	3 x 35 + 3 x 16/3**	27,7	30,7	162	1,800	332 363
	3 x 50 + 3 x 25/3**	32,5	35,5	202	2,540	332 364
	3 x 70 + 3 x 35/3**	39,1	42,1	250	3,570	332 365

Bus cables, twisted and shielded pairs or individual shielding

NGRDGÖU-O	6 x (2 x 0,5) C	22,1	25,1	2,5	0,850	332 366
	9 x (2 x 0,5) C	28,3	31,3		1,340	332 367
	6 x (2 x 1) C	28,1	31,1	18	1,250	331 767
	9 x (2 x 1) C	35,9	38,9		2,010	331 779
	12 x 1 (C)**	18,0	20,0		0,590	331 784



RONDOFLEX-RUBBER SHEATHED ROUND CABLES

shielded, for Cable Carriers



Application

Cable festoon systems for any kind of material handling equipment, machine tools etc. associated with high mechanical stresses and frequent bending during operation, especially where interferences between power cables and data transmission cables are to be expected. The high quality rubber compound allows for indoor and outdoor operation.

Technical data

Temperature range: - 25 bis + 90° C
 Nominal voltage U_0/U : 0,6/1 kV

Type	Number & size of conductors [mm ²]	Cross Section [mm ²]			O. D. [max. mm]	Capacity max. at 30 ° C* I_{max} [A]	Weight [kg/m]	Cat.-No.
		Power-conductor	Ground conductor	Shield				
NGRDGCGÖU-J	3 x 4 + 3 x 4/3	4	4	13	22,0	41	0,705	332 006
	3 x 6 + 3 x 6/3**	6	6	14	23,3	53	0,910	332 157
	3 x 10 + 3 x 10/3**	10	10	17	27,6	74	1,220	332 158
	3 x 16 + 3 x 16/3**	16	16	20	30,8	99	1,630	332 159
	3 x 25 + 3 x 16/3**	25	16	24	33,9	131	2,070	332 161
	3 x 35 + 3 x 16/3	35	16	28	36,1	162	2,450	332 162
	3 x 50 + 3 x 25/3	50	25	28	41,6	202	2,740	332 163

Design Features

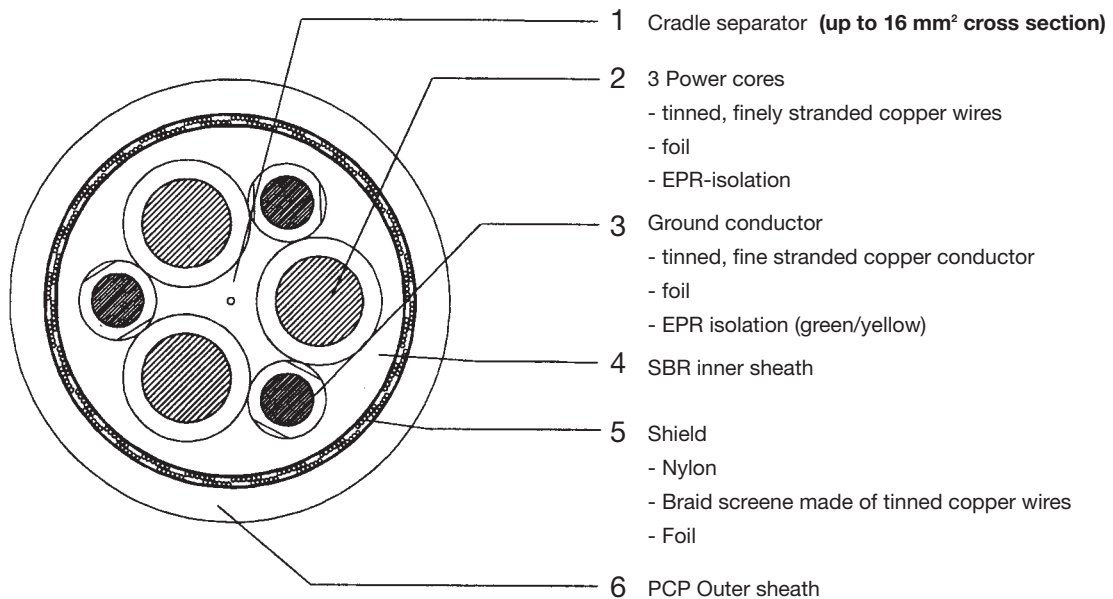

* De-rating factors are not considered (2. Selection of cables, page 4)

** Consult factory for delivery time



PVC CONTROL CABLES

with 2 Steel tension Reliefs for Cable Carriers



Application

Power and control cable for lifts and material handling equipment, control pendants, for dry and wet room and outdoors.

Technical data

Temperature ranger: - 30° C bis + 70° C
Nominal voltage U_0/U : 300/500 V

Type	Number & size of conductors [mm ²]	O. D. [mm]	Capacity max. at 30 ° C* I_{max} [A]	Weight [kg/m]	Cat.-No.
lift cable 2 TY	12 x 1	14,9 (27,3)	15	0,446	332 132
	18 x 1	17,0 (32,0)		0,528	331 939
	25 x 1	21,0 (36,0)		0,660	331 924
	30 x 1	21,9 (39,1)		0,760	332 133
	8 x 1,5	14,9 (27,3)	18	0,426	332 134
	12 x 1,5	16,5 (31,5)		0,505	331 992
	20 x 1,5	21,0 (36,0)		0,715	332 135
	24 x 1,5	22,6 (37,6)		0,820	332 136



VAHLE Flat Cable Festooning System for Container Crane Electrification.



NEOPRENE-CONTROL CABLES

with tension Relief for Cable Carriers



Application

Power and control cable for lifts and material handling equipment, control pendants, for dry and wet room and outdoor.

Technical data

Temperature rang: - 25° C bis + 80° C
Nominal voltage U_0/U : 300/500 V

Neoprene control cable with tension relief

Type	Number & size of conductors [mm ²]	O. D. [ca. mm]	Capacity max. at 30 ° C* I_{max} [A]	Weight [kg/m]	Tension strength/ relief core kg	Cat.-No.
STN	7 x 1	12,9	15	0,205	229	331 419
	12 x 1	18,5		0,390	674	331 420
	16 x 1	17,9		0,433	57	332 091
	18 x 1	19,2		0,472	96	331 421
	24 x 1	22,1		0,651	289	331 422
	36 x 1	26,1		0,910	96	331 423
	4 x 1,5	9,9	18	0,150	57	332 092
	5 x 1,5	10,9		0,181	87	331 424
	7 x 1,5	14,0		0,270	260	331 425
	8 x 1,5	15,2		0,310	346	331 426
	9 x 1,5	15,9		0,410	385	332 093
	12 x 1,5	19,9		0,510	771	331 427
	18 x 1,5	20,9		0,619	96	331 428
	24 x 1,5	23,4		0,818	385	331 429
	42 x 1,5	30,0	1,380	189	331 430	
	4 x 2,5	11,6	26	0,210	57	332 094
	7 x 2,5	16,6		0,380	346	332 095
	12 x 2,5	23,3		0,691	606	332 096
	24 x 2,5	28,5		1,222	606	332 097

Neoprene control cable with tension relief and common screening

Type	Number & size of conductors [mm ²]	O. D. [ca. mm]	Capacity max. at 30 ° C* I_{max} [A]	Weight [kg/m]	Tension strength/ relief core kg	Cat.-No.
STCN	6 x 0,5	11,5	2,5	0,180	150	331 436
	6 x 0,75	12,0	12	0,205	150	331 437
	4 x 1	11,5	15	0,185	25	331 431
	7 x 1	15,0		0,300	250	331 432
	12 x 1	20,5		0,545	250	331 433
	18 x 1	21,0		0,630	150	331 434
	24 x 1	25,0		0,900	250	331 435
	6 x 1,5	15,0	18	0,430	150	331 438

* De-rating factors are not considered (2. Selection of cables, page 4)



CABLE GLANDS



Polycarbonate and brass glands for flat cables

Protection code IP 54

Conduit nuts to be ordered separately

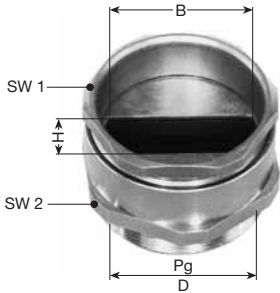

Pg Size	D mm	H mm	B mm	Polycarbonate			Brass		
				SW 1 mm	SW 2 mm	Cat.-No.	SW 1 mm	SW 2 mm	Cat.-No.
16	22,5	6	16	23	27	330 900	22	24	331 245
21	28,2	11	21	30	32	330 970	28	30	331 244
29	37,0	12	30	41	41	330 920	37	40	331 246
36	47,0	13	40	50	55	330 990	47	50	331 247
42	54,0	14	45	55	60	330 980	54	57	331 248
48-1	59,2	16	50	60	65	330 940	60	64	331 249
48-2	59,2	9	60	60	65	331 000	60	64	331 250

Aluminium and brass glands for flat cables

Protection code IP 54

Conduit nuts to be ordered separately

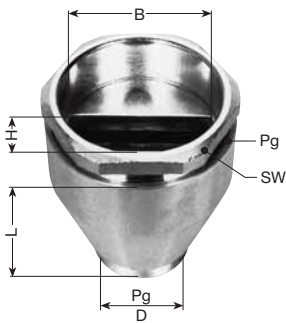

Pg Size	D	H	B	L	SW	Cat.-No.
	mm					
21/42	28,2	14	45	65	54	332 014
29/42	37,0	14	45	50	54	332 015
29/48-1	37,0	16	50	65	60	332 016
29/48-2	37,0	9	60	65	60	332 167

Polycarbonate and brass glands for round cables

Protection code IP 54

Conduit nuts to be ordered separately

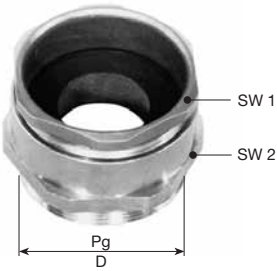

Pg Size	D mm	Polycarbonate				Brass			
		for cable-Ø mm range	SWB mm	SW 2 mm	Cat.-No.	for cable-Ø mm range	SWB mm	SW 2 mm	Cat.-No.
11	18,6	8 – 10	19	22	331 100	5 – 11	18	20	331 295
13,5	20,4	10 – 12	21	24	331 110	7 – 13	20	22	331 296
16	22,5	12 – 14	23	27	331 120	9 – 15	22	24	331 297
21	28,2	14 – 18	30	32	331 130	14 – 20	28	30	331 298
29	37,0	18 – 24	41	41	331 140	20 – 27	37	40	331 299
36	47,0	24 – 30	50	55	331 150	25 – 35	47	50	331 300
42	54,0	30 – 35	55	60	331 160	35 – 42	54	57	331 301
48	59,2	35 – 40	60	65	331 170	40 – 47	60	64	331 302

Polycarbonate and brass glands with tension relief and bending protection for round cables

Protection code IP 54

Conduit nuts to be ordered separately



Pg Size	D mm	Polycarbonate				Brass			
		for cable-Ø mm range	B mm	SW 2 mm	Cat.-No.	for cable-Ø mm range	B mm	SW 2 mm	Cat.-No.
11 K	18,6	8 – 10	32	22	331 180	5 – 11	26	20	331 303
13,5 K	20,4	10 – 12	35	24	331 190	7 – 13	29	22	331 304
16 K	22,5	12 – 14	38	27	331 200	9 – 15	32	24	331 305
21 K	28,2	14 – 18	47	32	331 210	14 – 20	38	30	331 306
29 K	37,0	18 – 24	67	41	331 220	20 – 27	50	40	331 307
36 K	47,0	24 – 30	77	55	331 230	24 – 36	57	50	331 308



COMPONENTS FOR CABLE GLANDS



Conduit Nuts GPg

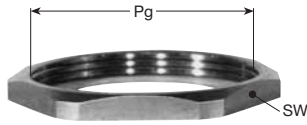

Pg Size	Polycarbonate		Brass	
	SW mm	Cat.-No.	SW mm	Cat.-No.
11	24	331 309	21	331 317
13,5	27	331 310	23	331 318
16	30	331 311	26	331 319
21	36	331 312	32	331 320
29	46	331 313	41	331 321
36	60	331 314	51	331 322
42	65	331 315	60	331 323
48	70	331 316	64	331 324

Sealing Rings DPg

Material: Polyethylene



Pg Size	Cat.-No.
11	331 496
13,5	331 497
16	331 498
21	331 499
29	331 500
36	331 501
42	331 502
48	331 503

Conduit Covers VPg

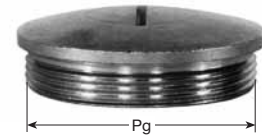

Pg Size	Polycarbonate Cat.-No.	Brass Cat.-No.
11	331 251	331 259
13,5	331 252	331 260
16	331 253	331 261
21	331 254	331 262
29	331 255	331 263
36	331 256	331 264
42	331 257	331 265
48	331 258	331 266

Reduction Fittings RPg

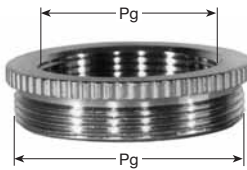

Pg Size	Polycarbonate Cat.-No.	Brass Cat.-No.
13,5/11	331 325	331 332
16 /13,5	331 326	331 333
21 /16	331 327	331 334
29 /21	331 328	331 335
36 /29	331 329	331 336
42 /36	331 330	331 337
48 /42	331 331	331 338

Extension Fittings EPg



Pg Size	Polycarbonate Cat.-No.	Brass Cat.-No.
11 /13,5	331 339	331 346
13,5/16	331 340	331 347
16 /21	331 341	331 348
21 /29	331 342	331 349
29 /36	331 343	331 350
36 /42	331 344	331 351
42 /48	331 345	331 352

Extension Fittings EPg

Material: aluminium

Pg Size	D _A	D _i	L	M	Cat.-No.
	mm				
21/42	57	24	65	15	313 056
29/42	57	32	50	15	312 611
29/48	65	32	65	16	313 057

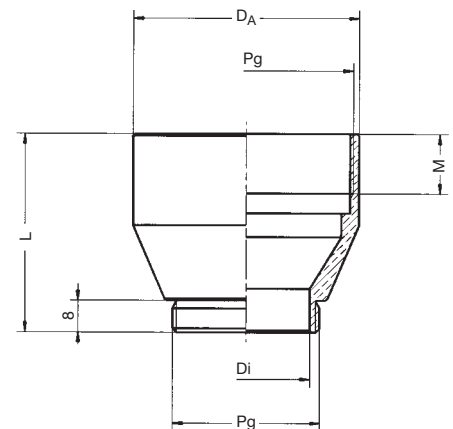



CABLE COMBINATION CONNECTOR

for flat and round Cables

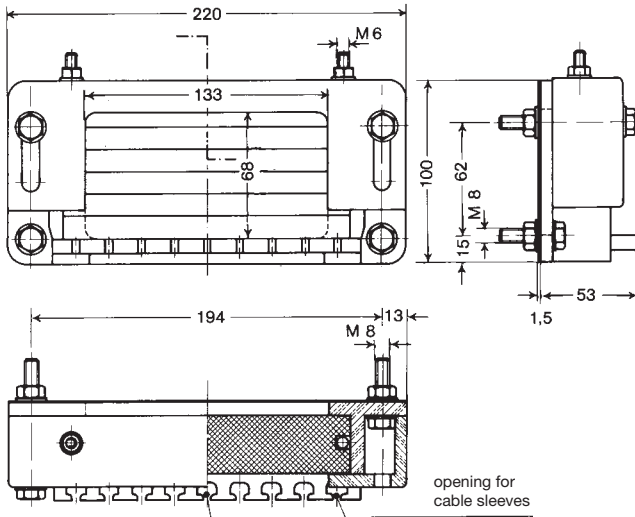

Connector for flat and round cables

Protection codet IP 54

Type	max. clamping capacity mm height x width	Material	Cat.-No.
FL 21	65 x 130	housing of aluminium with Neoprene sealings and galvanized hardware	331 241
Sealing Paste (sufficient for 2 connectors)			331 271

Installation instruction

1. Bolt the connector-flange to the terminal box using M 8 (A) bolts.
2. The lateral rubber elements (B) to be cut and inserted to suit your cable package.
3. Install the cables using sealing paste to fill open space. Use cable sleeves (C) to keep the cable package in position.

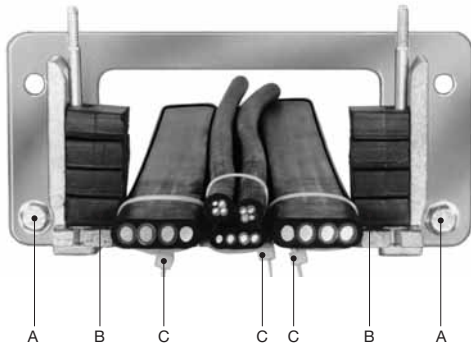

4. Flatten upper surface of cable package with sealing paste.
5. Fill in the remaining rubber elements (D).

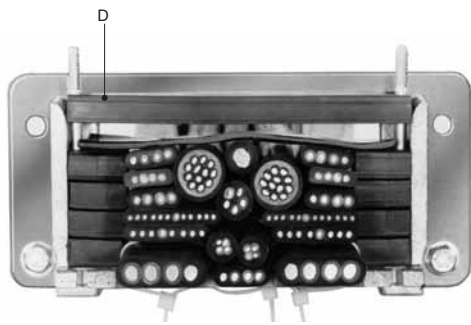

6. Affix cover /E/ via M 6 (F) bolts hand tight.
7. Insert the upper, long bolts M 8 (G) and tighten slightly.
8. Tighten M 6 (F) nuts.
9. Tighten M 8 (G) bolts.
10. Cable sleeves (C) can be removed.

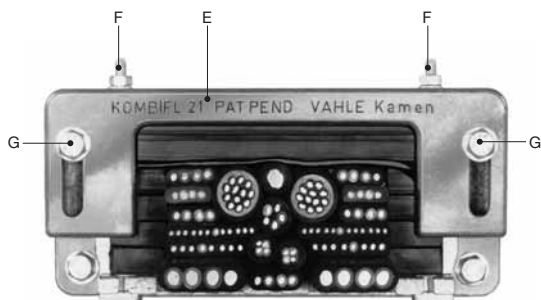



Cable connectors for flat cables

Flat cable Number & size of conductors	Insulation	Cable Connectors Type	B* mm	H* mm	Material	Cat.-No.
8 x 7 x 0,5 screened	PVC	VAC 66	66	11	housing of aluminium with Neopre- ne sealings and galvanized hardware	331 267
12 x 2,5 screened	Neoprene	VAC 68	68	7		331 268
7 x 10	Neoprene	VAC 63	63	11		331 269
7 x 16	Neoprene	VAC 73	73	14		331 270
5 x 25	Neoprene	VAC 63	63	11		331 269

* Opening dimensions B and H in the gasket must, if necessary, be modified to suit your cable.

Use **FL 21** connector, page 22 or larger flat cable sizes.

Protection code IP 54

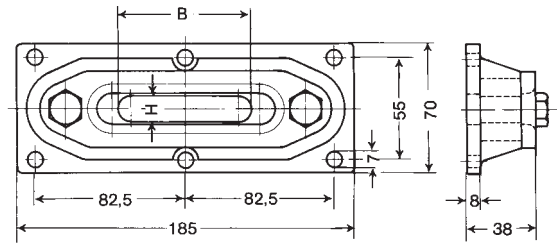

Round cable glands

Conduit nuts to be ordered separately

G	D mm	Brass			Cat.-No.
		for cable-Ø mm range	Di mm	SW mm	
2 1/2 "	75,1	42 – 47	59,5	81	332 168
		45 – 52			332 169
		51 – 55			332 171
		54 – 58			332 172
3 "	87,8	58 – 64	72,5	95	332 173
		63 – 70			332 174

Conduit nuts

for G	Brass	Cat.-No.
2 1/2 "	SW 81 mm	332 165
3 "	SW 95 mm	332 166

Protection code IP 68

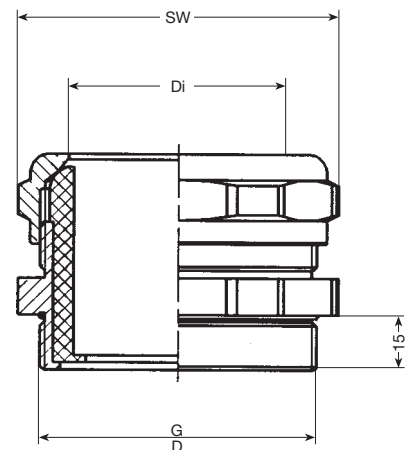

Round cable glands for welded attachment

Materials: housing galvanized steel
Sealing Neoprene
Hardware galvanized

Type	for cable-Ø dL mm range	Ø A mm	Ø B mm	max. E mm	Cat.-No.
Pg 76 S	71 – 76	110	100	63	331 465
Pg 81 S	76 – 81				331 274

Protection code IP 54

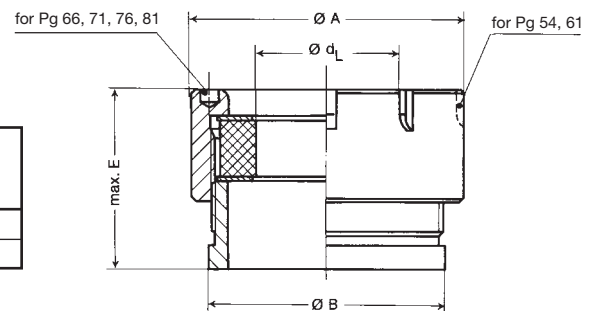

Round cable glands for bolted attachment

Materials: housing galvanized steel
Sealing Neoprene
Hardware galvanized

Type	for cable-Ø dL mm range	Ø A mm	□ C mm	□ D mm	max. E mm	Cat.-No.
Pg 76 F	71 – 76	110	95	115	63	331 468
Pg 81 F	76 – 81					331 277

Protection code IP 54

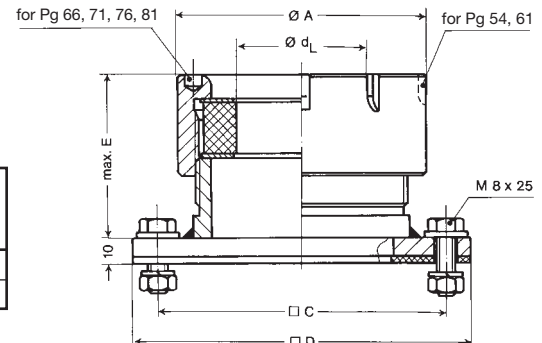

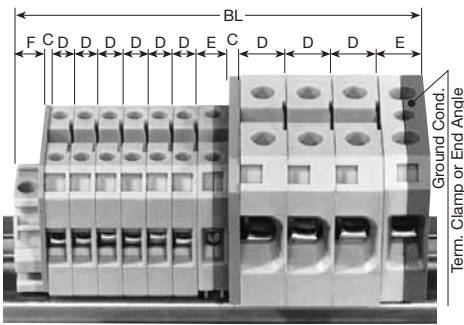

Technical details

Type	Material of Housing	Nominal Voltage	Nominal Amperage
SAK 2,5 PA	Polyamid	750 V ~ VDE 0110 Insulation Group C	27 A
SAK 4 PA			36 A
SAK 6 NPA			47 A
SAK 10 PA			65 A
SAK 16 PA			87 A
SAK 35 NPA			143 A
SAK 70 KrG	Polycarb.		220 A

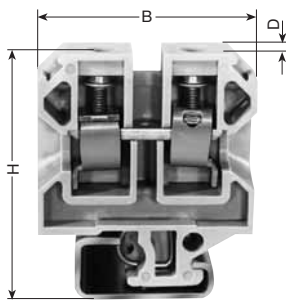

Terminal clamp

Type	Connection/ cross sect. area mm ²	H mm	B mm	D* mm	Cat.-No.
SAK 2,5 PA	0,5 – 2,5	46,5	36,5	6	330 800
SAK 4 PA	0,5 – 4	51,5	40	6,5	330 810
SAK 6 NPA	0,5 – 6	51,5	40	8	330 820
SAK 10 PA	1,5 – 10	51,5	40	10	330 830
SAK 16 PA	4 – 16	57,5	50	12	330 840
SAK 35 NPA	2,5 – 35	67,5	58	16	330 850
SAK 70 KrG	25 – 70	79,5	75	22	331 291



End plates

Type	for terminal clamps	H mm	B mm	C* mm	Cat.-No.
AP PA 2,5	SAK 2,5 PA	46,5	36,5	1,5	331 278
AP PA 4-10	SAK 4 PA bis 10 PA	51,5	40	1,5	331 279
AP PA 16	SAK 16 PA	57,5	50	1,5	331 280
AP PA 35	SAK 35 NPA	67,5	58	1,5	331 281
AP KrG 70	SAK 70 KrG	79,5	75	4	331 282

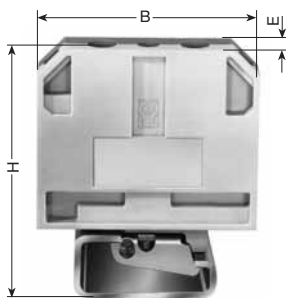

Terminal clamps for ground

Type	Connection/ cross sect. area mm ²	H mm	B mm	E* mm	Cat.-No.
EK 2,5 NPA	0,5 – 2,5	46,5	36,5	6	331 283
EK 4 PA	0,5 – 4	51,5	40	8	331 284
EK 10 PA	0,5 – 10	51,5	40	10	331 285
EK 16 PA	4 – 16	57,5	50	12	331 286
EK 35 PA	6 – 35	67,5	58	16	331 287

The ground clamp bridging for the support section has a green-yellow marking.

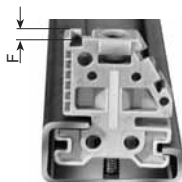

End angels

Type	for terminal clamps	F* mm	Cat.-No.
EWK 1	SAK 2,5 bis SAK 10	8,5	331 288
EWK 2	SAK 16 bis SAK 70	15	331 289

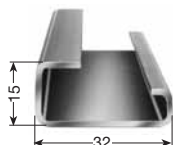

Support section

Type	Material	Length	Cat.-No.
TS 32	Stahl verzinkt	2 m	331 290



Noryl Terminal Boxes

Cable glands and terminal clamps to be ordered separately.

Type	AK 0		AK 1		AK 2	
Material	Noryl					
Hardware	galvanized					
Protection code	IP 54					
Dimensions L x B x H mm	115 x 115 x 70		190 x 150 x 100		280 x 200 x 140	
Terminal Block BL mm	60		130		220	
Cable glands	max. No.		max. No.		max. No.	
	A-side	C-side	A-side	C-side	A-side	C-side
Pg 16	2	2	6	6	12	12
Pg 21	2	2	5	5	10	10
Pg 29	1	1	4	4	8	8
Pg 36	–	–	2	2	4	4
Pg 42	–	–	2	2	3	3
Pg 48	–	–	2	2	3	3
Weight kg	approx. 0,280		approx. 0,500		approx. 1,300	
Cat.-No.	316 333		310 310		315 180	

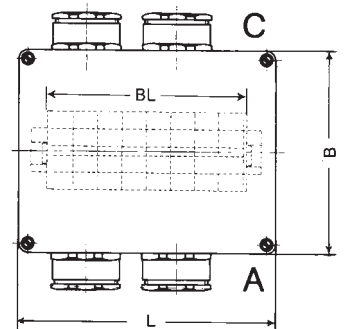
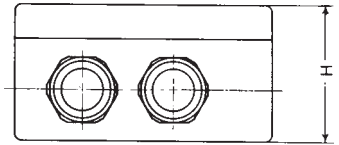

Steel Terminal Boxes

Cable glands and terminal clamps to be ordered separately.

Typ	AKST 1		AKST 2		AKST 3	
Material	steel					
Surface protection	two comp. paint DD/RAL 7032; hardware galv.					
Protection class	IP 65					
Dimensions L x B x H mm	200 x 150 x 120		300 x 200 x 120		400 x 200 x 120	
Terminal Block BL mm	160		260		360	
Cable glands	max. No.		max. No.		max. No.	
	A-side	C-side	A-side	C-side	A-side	C-side
Pg 16	8	8	16	16	16	16
Pg 21	8	8	12	12	16	16
Pg 29	4	4	8	8	8	8
Pg 36	2	2	4	4	6	6
Pg 42	2	2	4	4	5	5
Pg 48	2	2	3	3	4	4
Weight kg	approx. 2,100		approx. 2,950		approx. 3,720	
Cat.-No.	316 334		316 335		316 336	

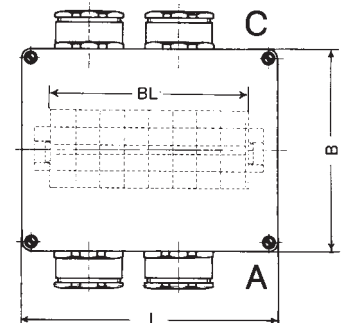
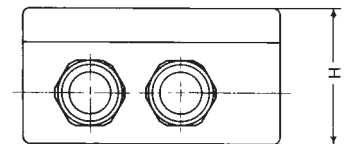



Cable tender with Round Conductor Cables.

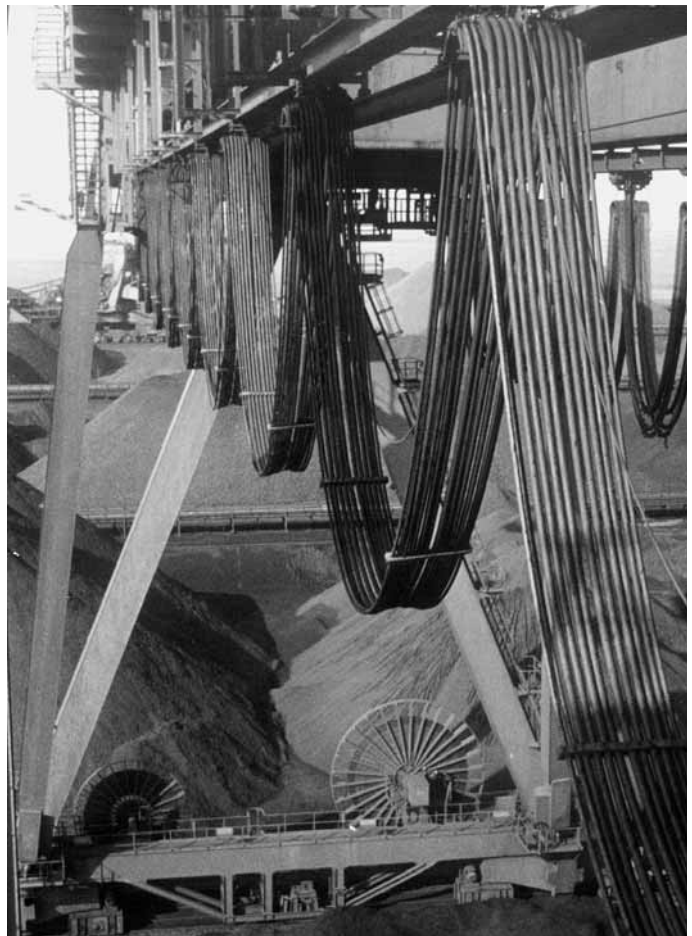

Round Cable Festooning System.

Stacker/Reclaimer Electrification via Cable Reels.



Motor Powered Cable Reel for Container Stacker Crane.



QUESTIONNAIRE

To our nearest local agency:

Name and Address of customer: _____

Reference: _____

Date: _____

1. For which type of application will the cable be used? _____

2. Outdoors _____ Indoors _____

3. Temperature range _____ °C min. _____ °C max.

4. Is round or flatform cable required? _____

5. Which type of cable guiding or carrying equipment are you planning? _____

Cable Carrier Cable Reel Cable Tender Other guiding device

6. Travelling speed _____ m/mm. Acceleration _____ m/s² or time of acceleration _____ s

7. Which power or ampacity to be carried simultaneously?

_____ kV _____ A

8. Operating voltage _____ V _____ Hz

9. Max. allowable voltage drop _____ V or _____ % for cable length _____ m

10. Required power and control cables _____

No. of cables	No. of conductors	Size of conductors [mm ²]	O. D. of round cable [mm]	Width x Thickness of flatform cables [mm]	Weight kg/m	Nominal current [A]	Starting current [A]

11. Can the number of conductors and the sizes be combined in one or in more cables?
yes no

12. Special operating conditions: _____

13. Further details: _____





DQS-zertifiziert nach
DIN EN ISO 9001
(Reg. Nr. 3140)

Catalog No.

Copperhead Conductor Systems	1 a
Battery Charging Systems	1 b
Insulated Conductor Systems U 10	2 a
Insulated Conductor Systems U 20 – U 30 – U 40	2 b
Insulated Conductor Systems U 15 – U 25 – U 35	2 c
Aluminium Enclosed Conductor Systems LSV – LSVG	3 a
Powerail Enclosed Conductor Systems KBSL – KSL – KSLT – KSG	4 a
Powerail Enclosed Conductor Systems VKS – VKL	4 b
Powerail Enclosed Conductor System MKLD – MKLF – MKLS	4 c
Heavy Enclosed Conductor Systems	5
Trolley Wire and Accessories	6
Cable Tenders	7
Cable Carriers for □-tracks	8 a
Cable Carriers for Flatform Cable on I-beams	8 bF
Cable Carriers for Round Cable on I-beams	8 bR
Cable Carriers for ◇-tracks	8 c
Conductor Cables and Fittings	8 L
Spring Operated Cable Reels	9 a
VAHLE POWERCOM® – Data Transmission Systems	9 c
CPS® – Contactless Power Supply	9 d
SMG – Slotted Microwave Guide	9 e
WCS – Position Encoding System	9 f
Motor Powered Cable Reels	10

